

# Examples of EDM'ed parts



**Engineering 165/265**

**April 12, 2017**

# Electron Gun Mesh Screen

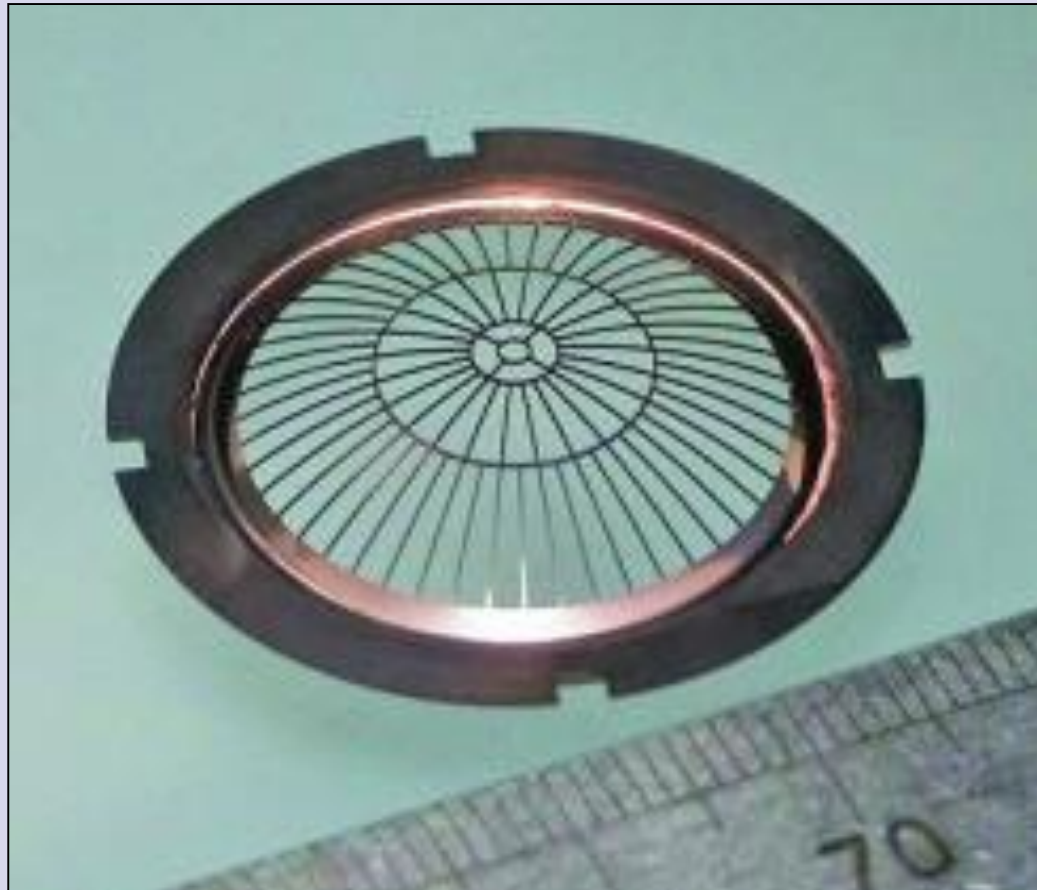
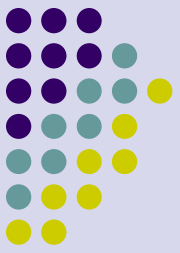

# Titanium Bone Screw

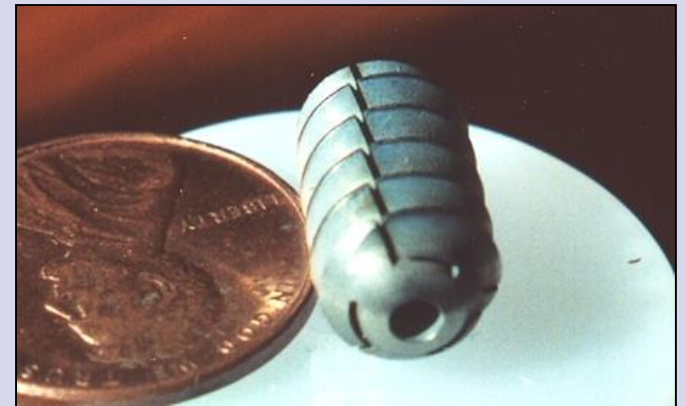
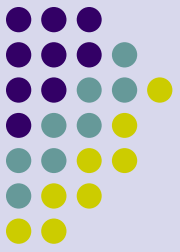

# Gerotor Blood Pump

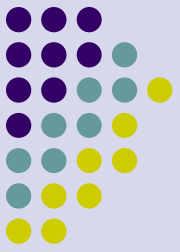

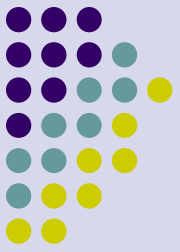

# Flexures – Laboratory

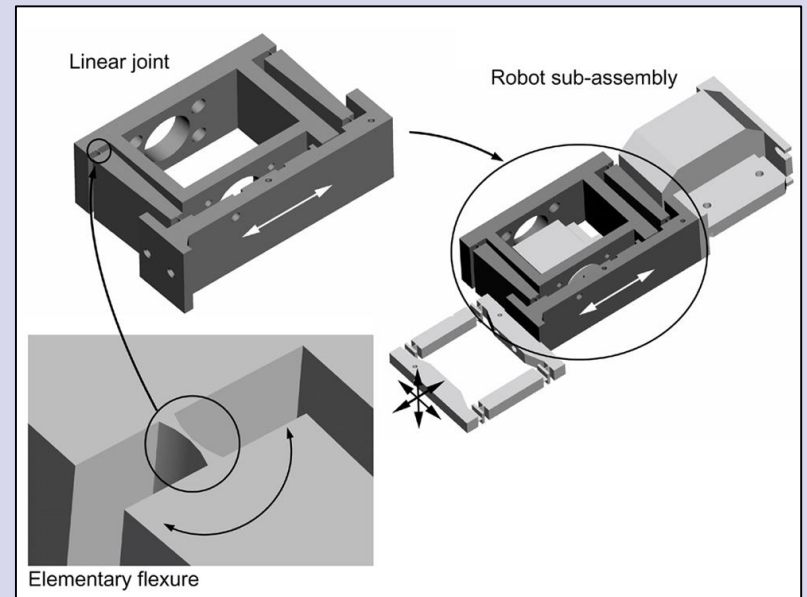
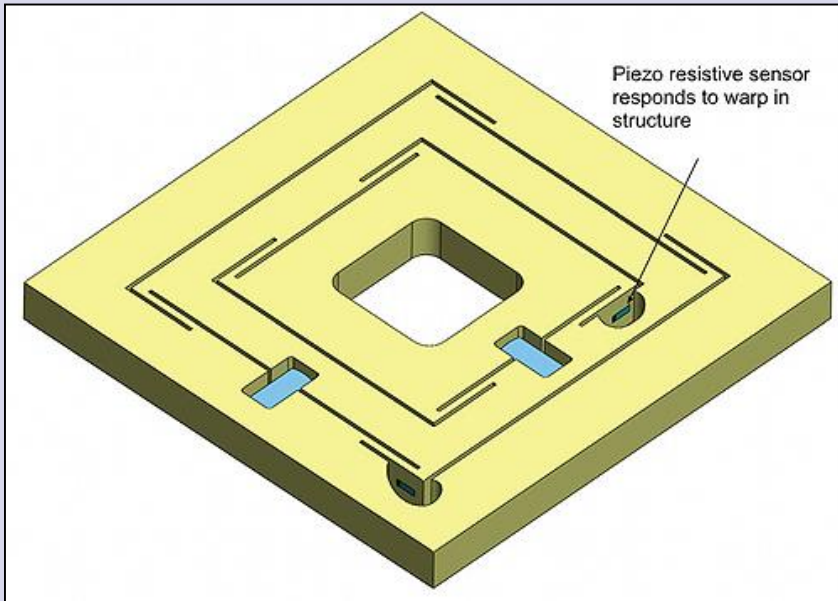

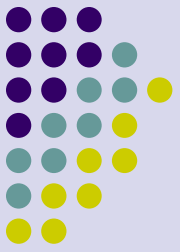

# Flexures - Mechanical

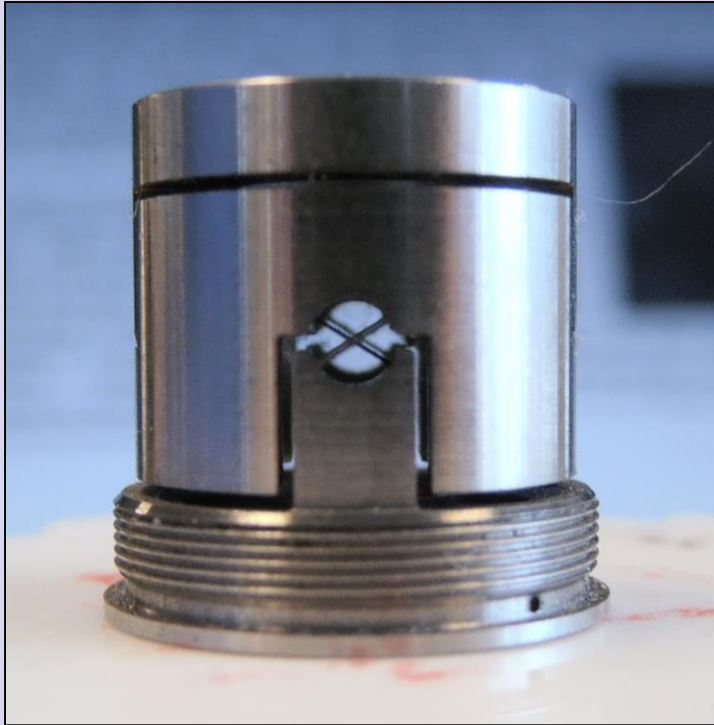

Cruise Missile

Postage Scale

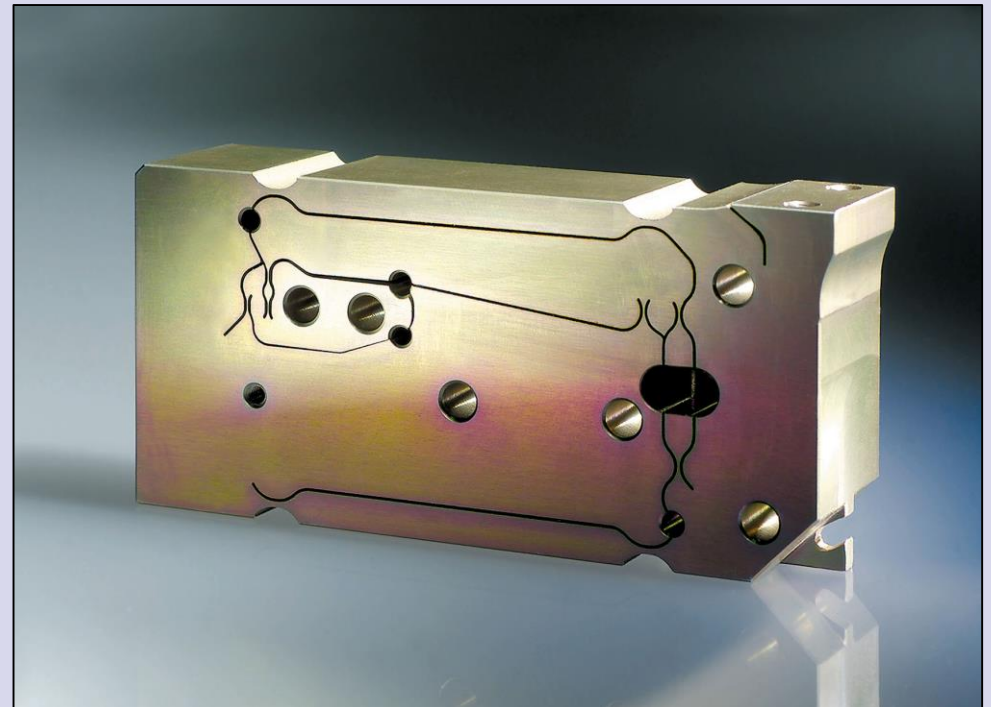

# Wave Guide - Electronics

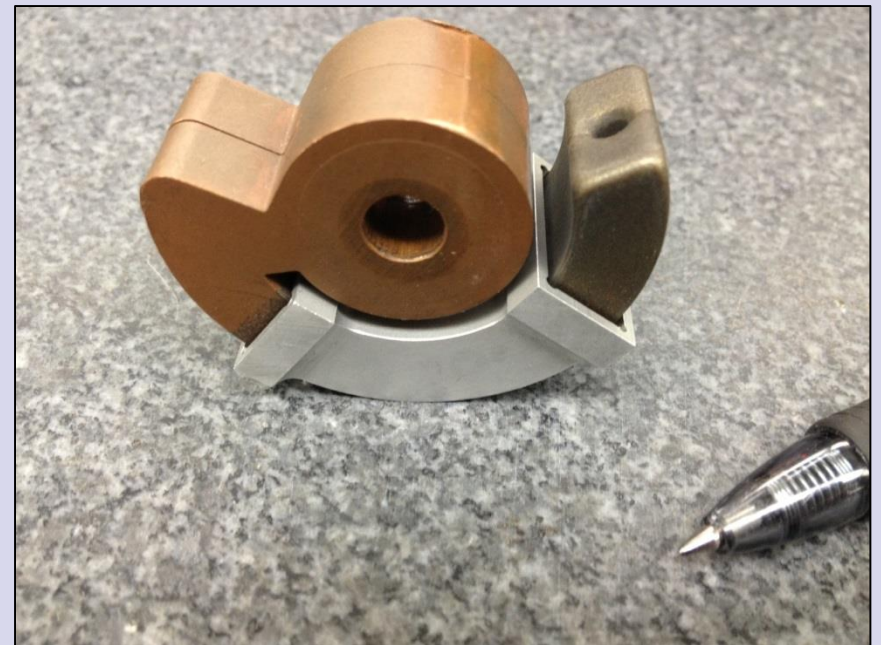
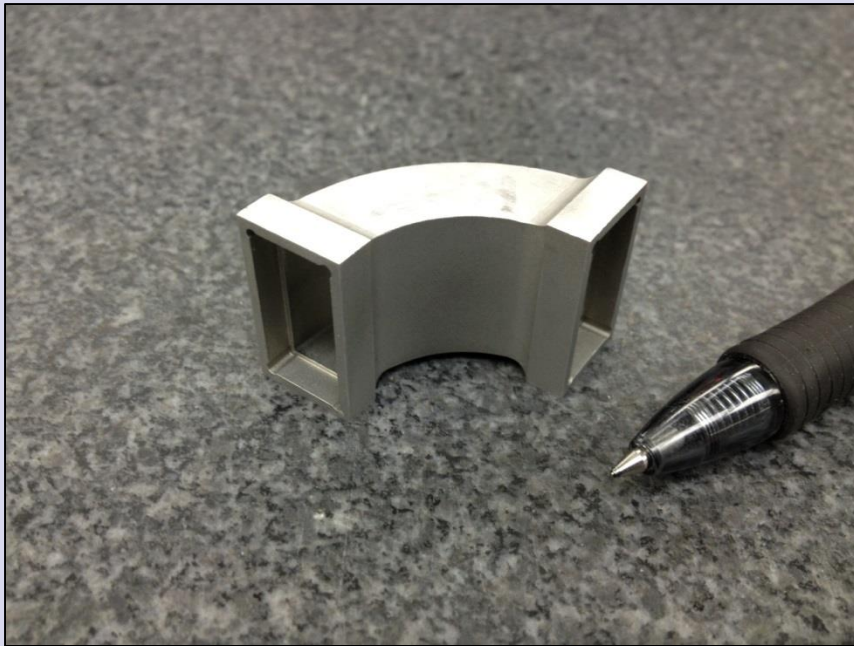
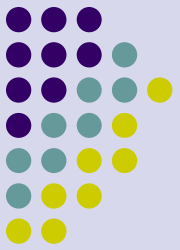

# Medical - Surgical

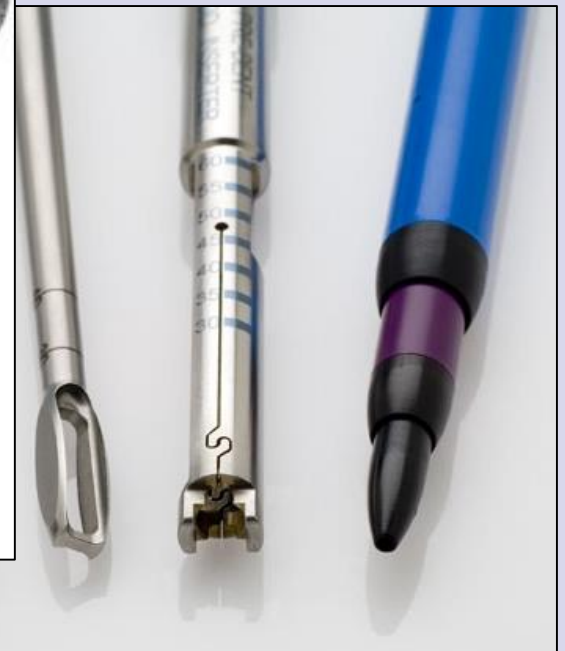
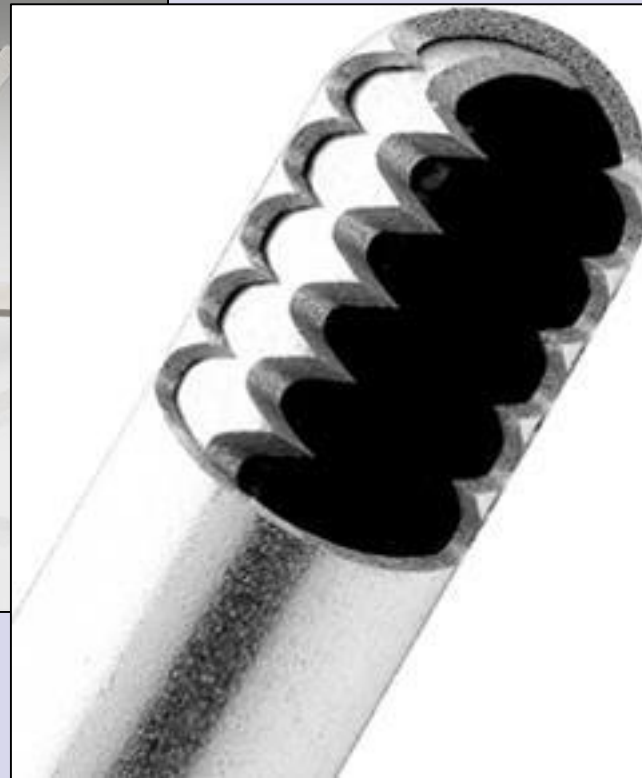
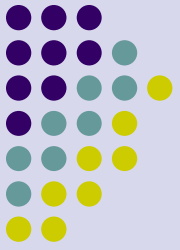



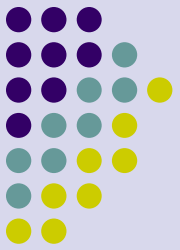

# Because we can...

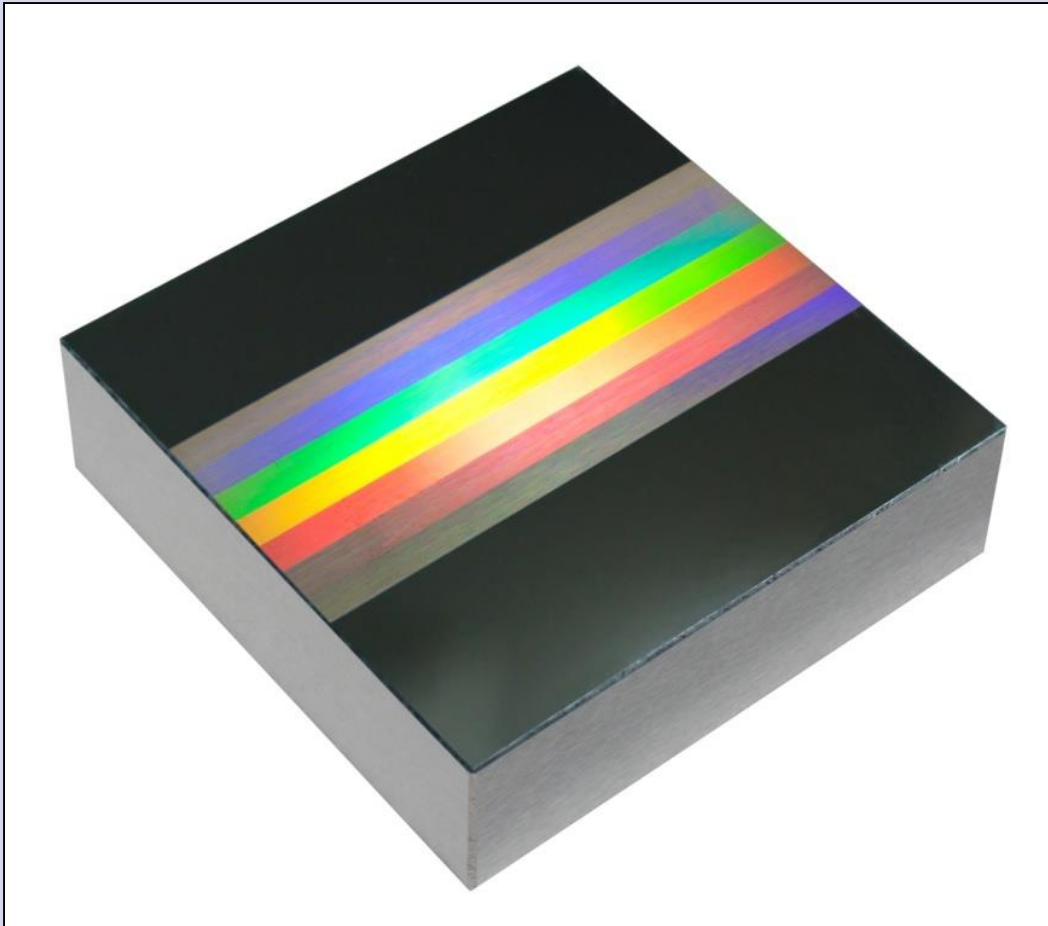

Color	wavelength
Purple	380 - 450
Blue	450 - 495
Green	495 - 570
Yellow	570 - 590
Orange	590 - 620
Red	620 - 750

Pitch	500	600	700
Depth	191	230	268

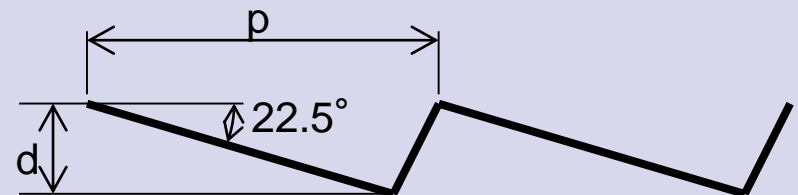

# Your presenter...

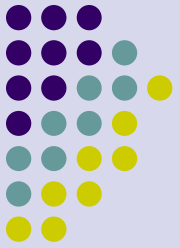

Author of:

**THE EDM HANDBOOK**

1997

Co-founder of:

**EDM TODAY Magazine**

1990

Author of:

**1st EDM section in  
MACHINERY'S HANDBOOK**

1997

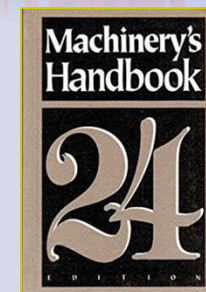
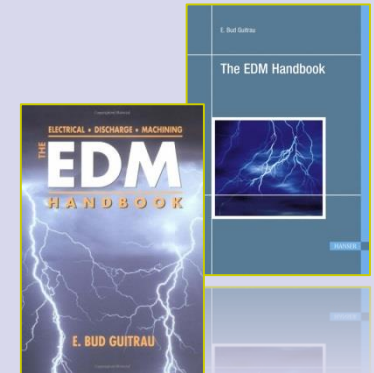

# If you have further interests...

---

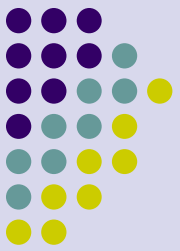

Contact: Bud Guitrau  
(714) 683-9586

[bud@edmtodaymagazine.com](mailto:bud@edmtodaymagazine.com)

<http://www.itp4edm.com>